

Federal Screen

Wedge Wire Screens

www.federalscreen.com



VESSEL INTERNALS

... FOR SAND FILTERS, CARBON FILTERS, ION EXCHANGE UNITS

Available as both Header Lateral and Hub Lateral assemblies, Federal Screen wedge wire screen laterals and pipe based laterals can be connected to distributor headers and spider hubs by the following methods :

- standard NPT threaded connections
- flanged connections... fabricated or ANSI
- welded as one assembly

Laterals are available in all standard pipe and tube outside diameters.

Pipe Base Laterals...

complete with drilled internal pipe for maximum flow distribution

Cutaway showing
internal drilled pipe

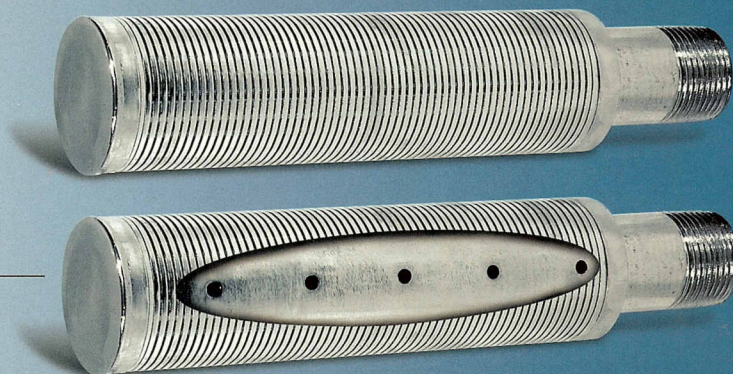

Screen Laterals...

supplied with various standard end fittings or custom fittings to suit your design



Header & Hub Laterals...

available in a variety of standard designs or can be custom fabricated to meet your requirements

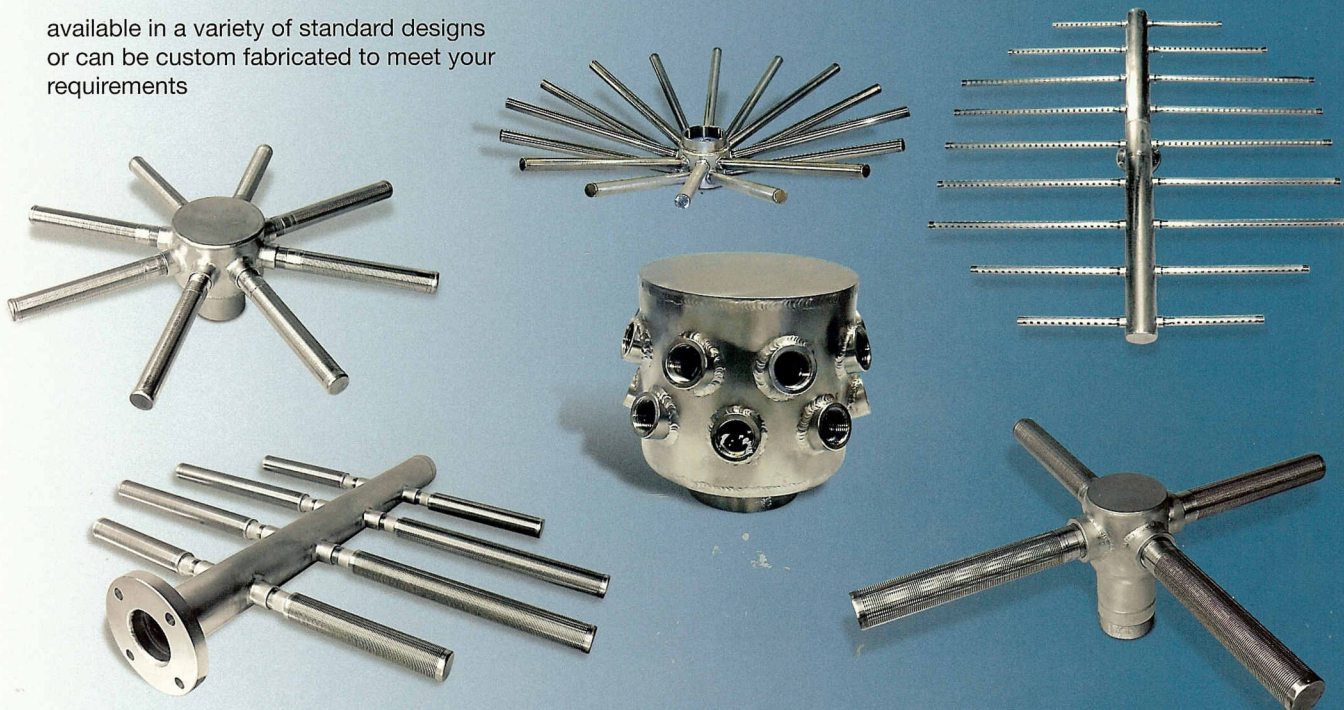

APPLICATIONS

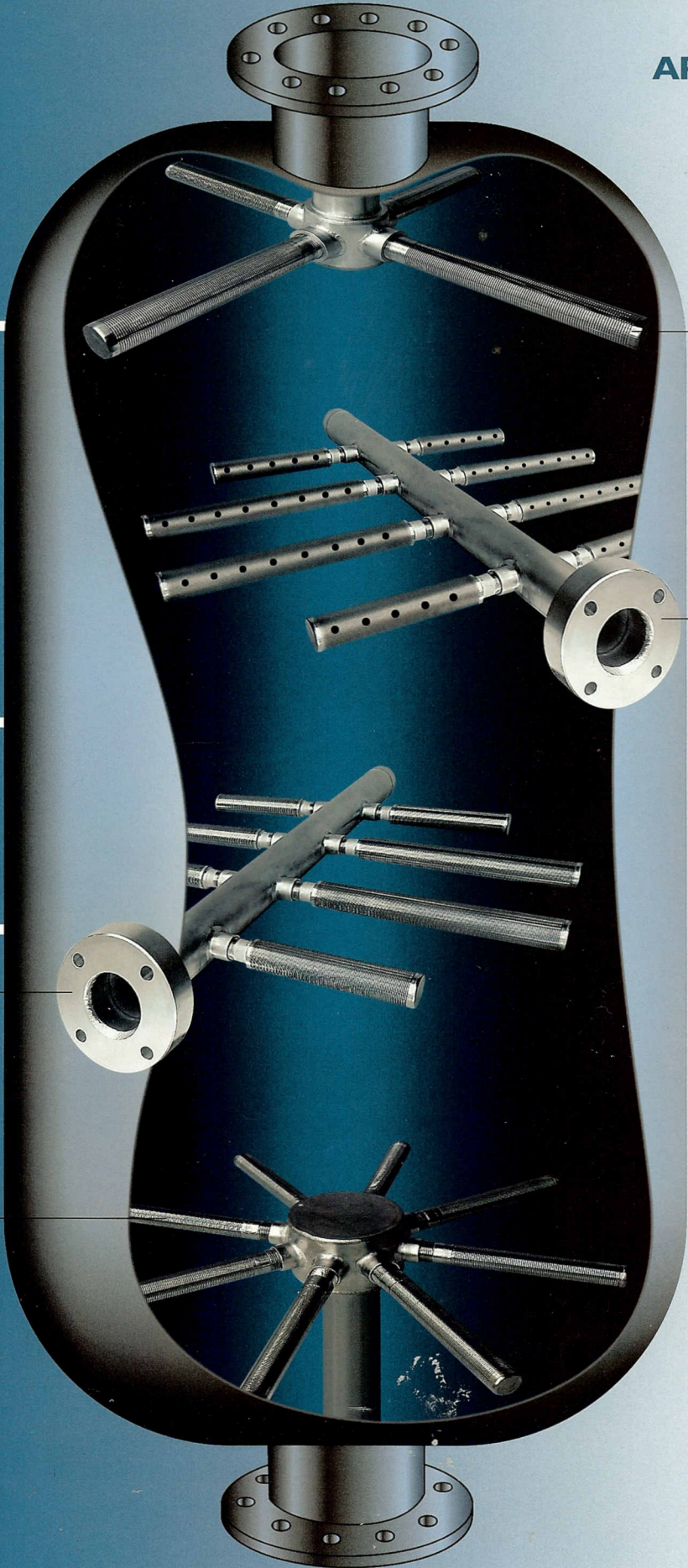

Inlet Distributor

Air Sparge Header Assembly

Side Outlet Header Assembly

Bottom Outlet Hub Assembly



MEDIA RETENTION NOZZLES & INLET DISTRIBUTORS

... FOR EFFECTIVE TREATMENT MEDIA RETENTION

Commonly made of stainless steel, Federal Screen nozzles are available in a variety of alloys, all providing a high percentage of open area while maintaining exceptional strength and efficiency.

A variety of custom and standard designs are available with slot sizes to suit your application. Our design department is ready to assist you in meeting special requirements for custom applications.

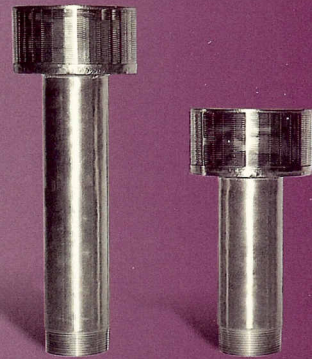

Standard
Male / Female Nozzle



Economy
Male / Female Nozzle



Nozzle Assembly

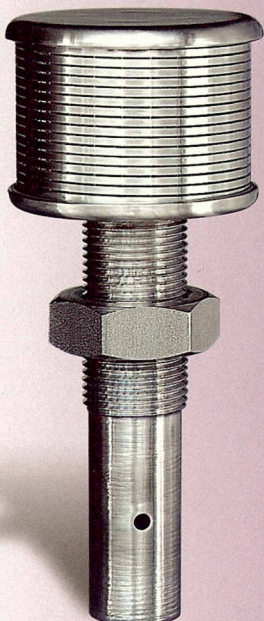

Custom Nozzles

APPLICATIONS

Inlet
Splash-Plate
Assembly

Inlet Screen
Distributor

Tube Sheet / False Bottom
Nozzle Arrangements

Resin Trap

RESIN TRAPS

Federal Screen offers a complete range of resin trap styles to suit virtually any application. All are available in a full range of construction materials with a variety of connecting flanges and housings.

Federal Screen resin traps provide a high percentage of open area thus minimizing pressure loss through the system. Your resin trap can be designed to suit either new or existing strainer bodies.



STRAINER BASKETS

Federal Screen wedge wire strainer baskets are commonly used in applications where :

- perforated baskets do not provide sufficient open area
- mesh weave baskets are not suitable for the required pressure differential
- the cost of a combination perforated with mesh lined basket is not economical

Federal Screen baskets can be designed for new or existing strainer bodies and can be engineered for various flow directions.



CUSTOM SUPPORT GRIDS

Offered in welded construction, these screens are available in a variety of framing options and designs, from one piece construction to multiple sections for on-site assembly and ease of retrofitting through existing manways.

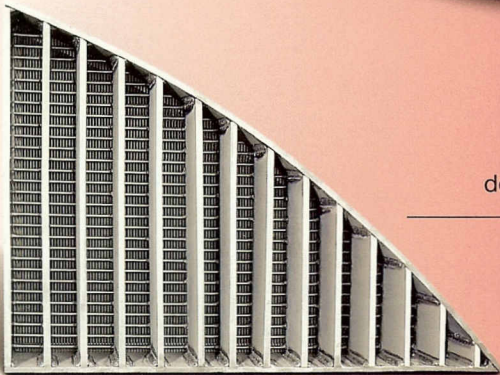
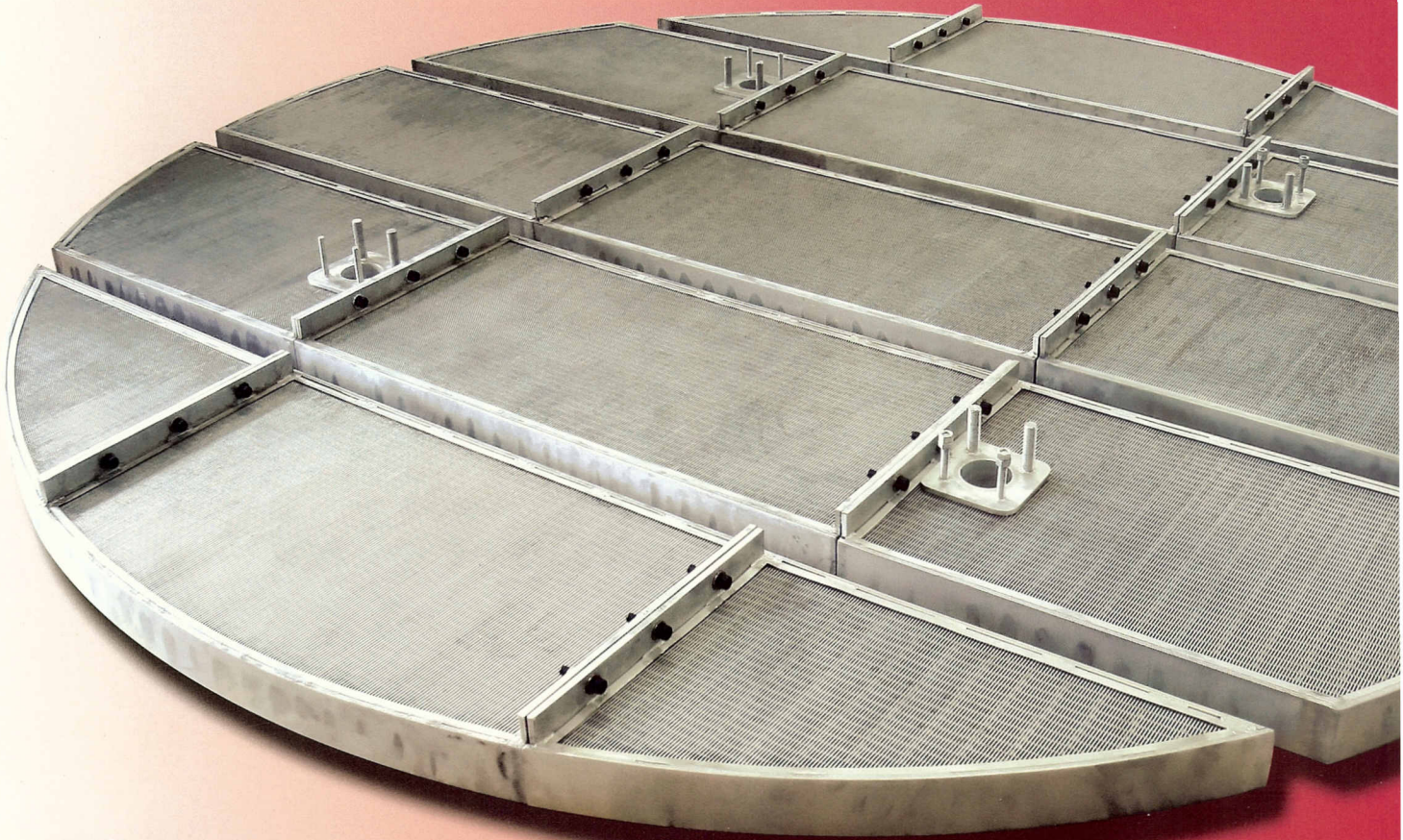

Support Structures...
designed to meet your specific load
and pressure requirements

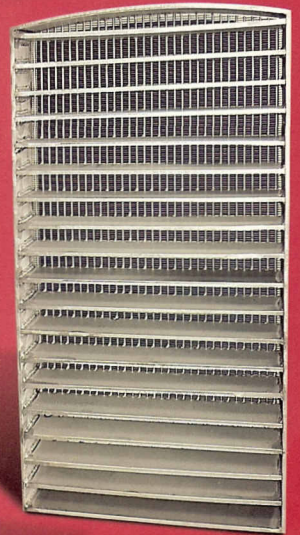

High Volume Submerged
Intake Screen

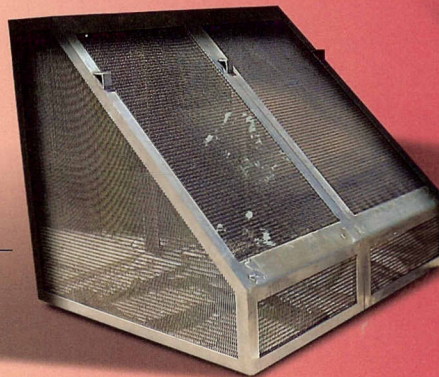

CONSTRUCTION PROFILES

Flow Outside In

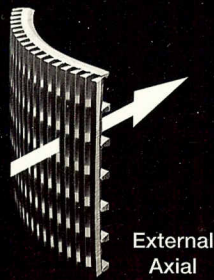
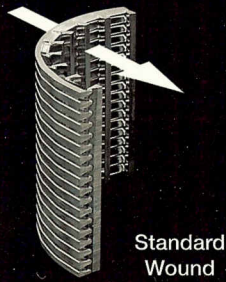

Flow Inside Out

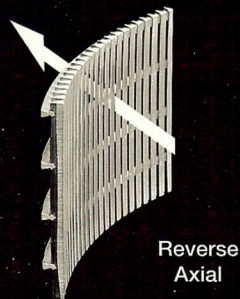
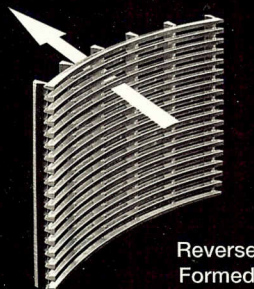
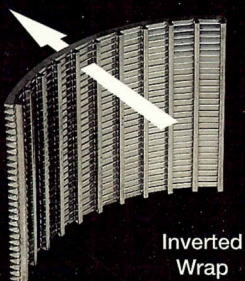

$$\text{Open Area (\%)} = \frac{\text{Slot Size} \times 100}{\text{Slot Size} + \text{Wire Width}}$$

WIRE MATERIALS

- 304 SS • 316L SS • 321 SS • 347 SS
- DUPLEX SS • ALLOY 20 • HASTELLOY® C-276
- ALLOY B-3 • TITANIUM • MONEL 400

WIRE PROFILES & RIB SUPPORT

No. 30 	No. 40 	No. 47
No. 60 	No. 90 	No. 125
No. 177 	No. 250 	CUSTOM

PARTICLE SIZE

U.S. MESH	INCHES	MICRONS	MILLI-METERS
3	.265	6730	6.73
3½	.223	5660	5.66
4	.187	4760	4.76
5	.157	4000	4.00
6	.132	3360	3.36
7	.111	2830	2.83
8	.0937	2380	2.38
10	.0787	2000	2.00
12	.0661	1680	1.68
14	.0555	1410	1.41
16	.0469	1190	1.19
18	.0394	1000	1.00
20	.0331	841	.84
25	.0280	707	.71
30	.0232	595	.59
35	.0197	500	.50
40	.0165	420	.42
45	.0138	354	.35
50	.0117	297	.297
60	.0098	250	.250
70	.0083	210	.210
80	.0070	177	.177
100	.0059	149	.149
120	.0049	125	.125
140	.0041	105	.105
170	.0035	88	.088
200	.0029	74	.074
230	.0024	63	.063
270	.0021	53	.053
325	.0017	44	.044
400	.0015	37	.037



Federal
Screen Products Inc.

7524 Bath Road
Mississauga, Ontario
Canada L4T 1L2

TEL: (905) 677-4171
FAX: (905) 677-8959
www.federalscreen.com

Represented by: